

M A T E R I C H E



**PORTE NOBILITATE IN LAMINATINO:
ISY, ISY PLUS, VINTAGE,
LIGHT PLUS, NEW TWIN SET**

*LAMINATE DOORS:
ISY, ISY PLUS, VINTAGE,
LIGHT PLUS, NEW TWIN SET*

THE ITALIAN STYLE DOOR

Dierre
YOUR HOME. YOUR LIFE

M A T E R I C H E

Le informazioni presenti in questo catalogo possono subire variazioni.
I materiali rappresentati sono puramente indicativi: per la verifica dei colori si rimanda al campionario.
*The information contained in this catalogue may undergo variations.
The materials shown are a bare example: for the verification of colours please refer to the sample collection.*

PORTE NOBILITATE IN LAMINATINO
LAMINATE DOORS



M A T E R I C H E

PORTE NOBILITATE IN LAMINATO

Niente è in grado di completare e caratterizzare l'aspetto di una casa più delle nuove porte interne Dierre. Le Materiche, nate per sorprendere ed emozionare, arredano e rinnovano per fondersi con armonia secondo il tuo gusto negli ambienti della casa, grazie a finiture che simulano la materia sia alla vista che al tatto: dalle calde venature del legno, alla fredda durezza del cemento.

LAMINATE DOORS

The look of a house can be completed and characterized by nothing better than the new Dierre interior doors. The Materiche series, conceived to surprise and enchant thanks to finishes that simulate the material both to the sight and to the touch are able to furnish and renew to harmoniously blend according to your taste within the rooms of the house: from the warm wood grains, to the cold hardness of cement.

ISY COLLECTION

ISY PLUS	8
ISY	22

EXPRESS COLLECTION

VINTAGE	40
LIGHT PLUS	56

NEW TWIN SET

66

GUIDA ALLA SCELTA DELLE COLLEZIONI (TAVOLA SINOTTICA) GUIDE TO THE CHOICE OF COLLECTIONS (SYNOPTIC TABLE)

77



Isy Plus 13 palissandro bianco matrix con inserti in vetro laccato RAL 7043
Isy Plus 13 matrix white rosewood with lacquered glass inserts RAL 7043

ISY COLLECTION

Emozioni al tatto e dettagli di alta qualità per porte che restituiscono le sensazioni del legno. Moderne e pratiche grazie a soluzioni come la serratura magnetica e uno speciale telaio uguale dal lato a spingere e da quello a tirare.

Emotions to the touch and high quality details for doors that give back the sensations of wood. Modern and practical thanks to solutions such as the magnetic lock and a special frame that is the same on the push and pull side.



ISY PLUS



ISY

ISY PLUS

Isy Plus 13 bianco matrix
con inserti in vetro laccato verde salvia
(NCS S 2030 - G60Y)

Isy Plus 13 matrix white
with sage green lacquered glass inserts
(NCS S 2030 - G60Y)

ISY PLUS

Porta a profilo rivestita in laminato con pannellature cieche o vetrate, con telaio in listellare e coprifili in multistrato, struttura dei profili in listellare/MDF rivestito. Serratura magnetica, cerniere a doppio gambo e/o a scomparsa registrabili su 3 assi di serie.

Laminate panelled profile door with blank or glazed panels, with blockboard frame and multilayer casing, melamine panelled blockboard/MDF structure of the profiles. Magnetic lock, double stem or concealed hinges adjustable on 3 axes.



Il telaio listellare e il coprifilo multistrato garantiscono una elevata resistenza all'umidità. I coprifili da 9 cm con alette telescopiche da 28 mm compensano perfettamente gli spessori parete fuorimisura e garantiscono la stessa altezza sia sul lato a spingere sia su quello a tirare.

The block board frame and the multilayer casing ensure high resistance to humidity. The 9 cm casing with 28 mm flap perfectly compensate any uneven wall dimensions and guarantee the same height both on the push and pull side.



Serratura magnetica. Lo scrocco indipendente dal magnete permette sempre la chiusura della porta. Incontro sul telaio di tipo registrabile che agevola la fase di posa in opera.

Magnetic lock. The latch is independent from the magnet and always allows the closing of the door. Adjustable frame striker that aids the fitting stages.

Cerniera registrabile su 3 assi a doppio gambo con cover in cromo satinato. Double stem hinge with satin chrome cover.

Cerniera a scomparsa registrabile su 3 assi con cover in finitura alluminio. Hinge with aluminium finish cover.



Forcelle di assemblaggio per sostituzione e/o predisposizione vetro su porte finestrate (a richiesta). Assembly forks for glass replacement and/or presetting on French doors (on request).

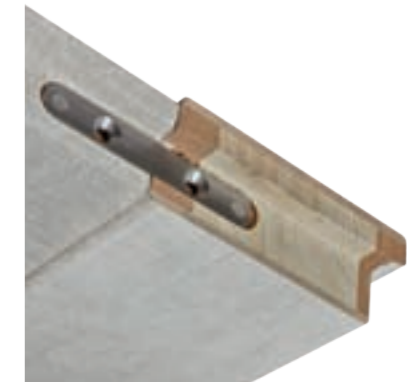

Versione Isy Plus 4
Colore Palissandro bianco matrix
Coprifilo Modello Liscio
 dimensione mm 90x10

Variant Isy Plus 4
Colour Matrix white rosewood
Cover mould Liscio model,
 dimension mm 90x10

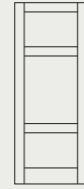

Versione Isy Plus 5
Colore Beton maloja
Coprifilo Modello Liscio
 dimensione mm 90x10

Variant Isy Plus 5
Colour Marbled beton maloja
Cover mould Liscio model,
 dimension mm 90x10



Versione Isy Plus 9
Colore Bianco matrix
Coprifilo Modello Liscio
 dimensione mm 90x10

Variant Isy Plus 9
Colour Matrix white
Cover mould Liscio model,
 dimension mm 90x10

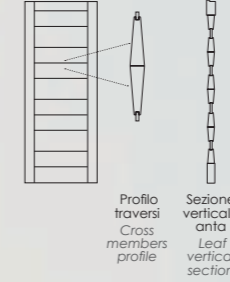

Versione Isy Plus 13 finestrata
Colore Bianco matrix
Coprifilo Modello Liscio
 dimensione mm 90x10

Variant Isy Plus 13 glazed
Colour Matrix white
Cover mould Liscio model,
 dimension mm 90x10



Il colore degli inserti in vetro non è reale
 The color of glass inserts is not realistic

allestimenti *lines*

ISY PLUS 1

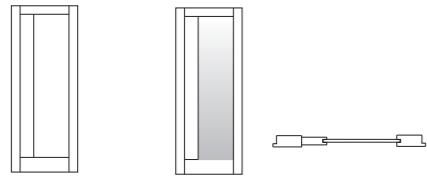

cieca con foderina
blank with flat panel

finestrata
glazed

Sezione orizzontale anta
Leaf horizontal section

ISY PLUS 2

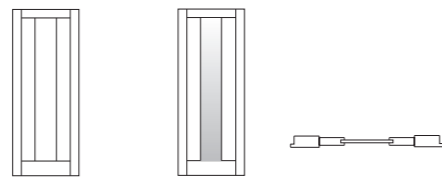

cieca con foderina
blank with flat panel

finestrata
glazed

Sezione orizzontale anta
Leaf horizontal section

ISY PLUS 3

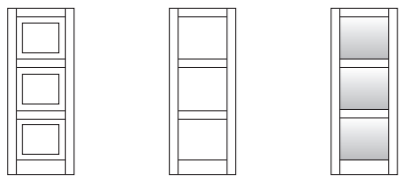

cieca con bugna
blank with raised panel

cieca con foderina
blank with flat panel

finestrata
glazed

ISY PLUS 4

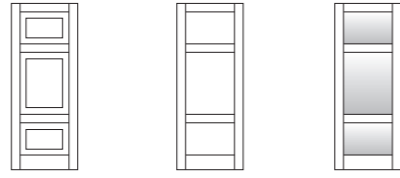

cieca con bugna
blank with raised panel

cieca con foderina
blank with flat panel

finestrata
glazed

ISY PLUS 8

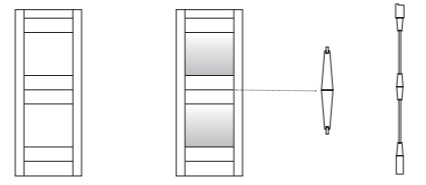

cieca con foderina
blank with flat panel

finestrata
glazed

Profilo traversi
Cross members profile

Sezione verticale anta
Leaf vertical section

ISY PLUS 9

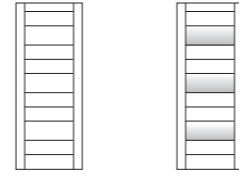

cieca con foderina
blank with flat panel

finestrata
glazed

ISY PLUS 10

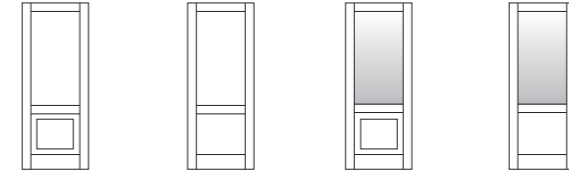

cieca con bugna
blank with raised panel

cieca con foderina
blank with flat panel

finestrata
glazed

finestrata
glazed

ISY PLUS 5

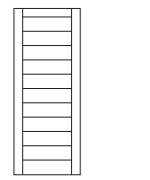

cieca con traversi orizzontali
Blank with horizontal cross members

ISY PLUS 6

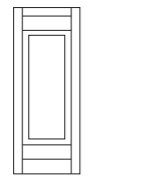

cieca con bugna
blank with raised panel

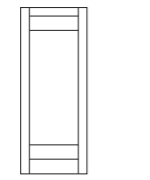

cieca con foderina
blank with flat panel



finestrata
glazed

ISY PLUS 11



cieca con bugna
blank with raised panel



cieca con foderina
blank with flat panel



finestrata
glazed

ISY PLUS 12



cieca con foderina
blank with flat panel



finestrata
glazed

ISY PLUS 13



cieca con bugna
blank with raised panel



finestrata
glazed



Sezione orizzontale anta
Leaf horizontal section

ISY PLUS 7

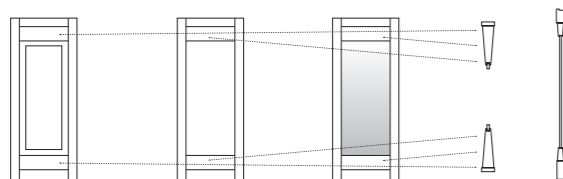

cieca con bugna
blank with raised panel

cieca con foderina
blank with flat panel

finestrata
glazed

Profilo traversi
Cross members profile

Sezione verticale anta
Leaf vertical section

ISY PLUS 14

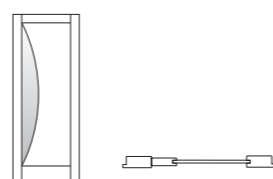

finestrata
glazed

Sezione orizzontale anta
Leaf horizontal section

ISY PLUS 15

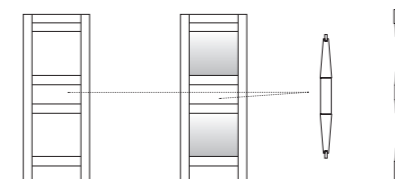

cieca con foderina
blank with flat panel

finestrata
glazed

Profilo traversi
Cross members profile

Sezione verticale anta
Leaf vertical section



Isy Plus palissandro bianco matrix
Isy Plus matrix white rosewood

Extra



Resistenza all'umidità
Legno listellare e multistrato
resistente all'acqua
Resistance to moisture
Water resistant blockboard and multilayer



Sigillo di autenticità
Authenticity seal



Serratura magnetica
Magnetic lock



Finitura coordinata per tutte le porte di casa,
del rivestimento blindato e del battiscopa
Coordinated finishing for all the doors
of your house, security door panelling
and skirting

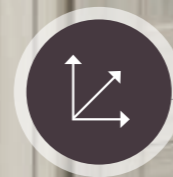

Cerniera registrabile su tre assi
sia per versione cerniera doppio gambo
che cerniera scomparsa
Adjustable hinge on three axes
for both double stem hinge
and concealed hinge

soluzioni di apertura *opening variant*

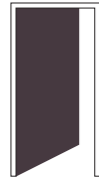

Battente singolo
Single leaf



Doppio battente
Double leaf

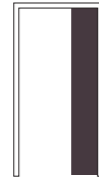

Scorrevole interno muro singolo
Single leaf sliding inside the wall



Scorrevole interno muro 2 ante
Two opposing leaves sliding inside the wall



Scorrevole esterno muro
One leaf sliding outside the wall

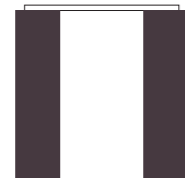

Scorrevole esterno muro 2 ante
Outside the wall sliding door with two single leaves

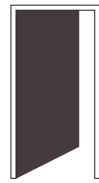

Battente singolo con cerniere invisibili
Single leaf with invisible hinges

soluzioni telaio in legno *wooden frame options*



TELAIO STANDARD con cerniera Anuba
STANDARD FRAME with Anuba hinge

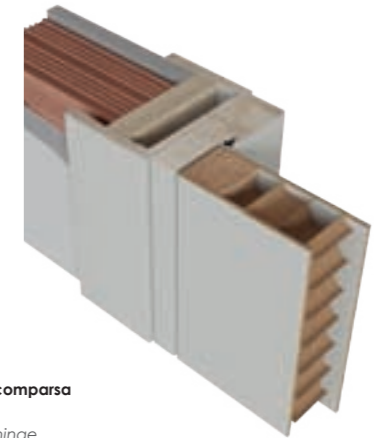

TELAIO SPECIALE con cerniera a scomparsa
Special frame with concealed hinge

essenze e colorazioni *wood types and colors*

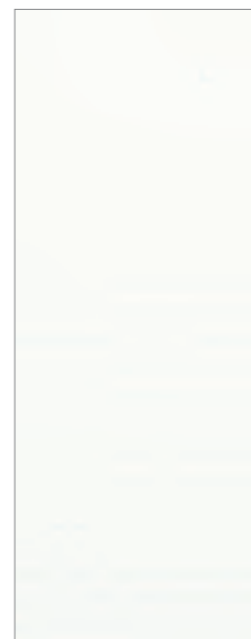

Bianco matrix
Matrix white



Palissandro bianco matrix
Matrix white rosewood



Marmorizzato beton maloja
Marbled beton maloja





Isy Rasé beton maloja e in abbinamento il rivestimento del blindato
 Isy Rasé beton maloja matched to a security door panelling

ISY

Versatile, originale, contemporanea, Isy è una porta per interni particolarmente facile da collocare in ogni spazio della casa grazie all'ampia gamma di colorazioni e sfumature disponibili. La struttura in listellare del telaio e il particolare coprifiolo in multistrato mettono in risalto la forza espressiva del legno che, come una volta, ritorna ad essere il protagonista della porta moderna.

Versatile, peculiar, contemporary, Isy is a door for interiors particularly easy to fit within every space of the house thanks to the wide range of available colors and shades. The structure of the slat frame and the particular multilayer casing make the expressive strenght of wood stand out that - as it used to be - comes be to be the star of modern doors.



Il telaio listellare e il coprifiolo multistrato garantiscono una elevata resistenza all'umidità. I coprifioli da 9 cm con alette telescopiche da 3 cm compensano perfettamente gli spessori parete fuorimisura e garantiscono la stessa altezza sia sul lato a spingere sia su quello a tirare. L'anta è montata sul telaio assemblato: questo sistema garantisce una veloce posa in opera e permette di evitare errori di misure e di registro della porta.

The block board frame and the multilayer casing ensure high resistance to humidity. The 9 cm casing with 3 cm flap perfectly compensate any uneven wall dimensions and guarantee the same height both on the push and pull side. The wing is mounted on the frame: this assembly system ensures quick installation and allows to avoid errors in the measurement and adjustment of the door.



Serratura magnetica. Lo scrocco indipendente dal magnete permette sempre la chiusura della porta. Incontro sul telaio di tipo registrabile che agevola la fase di posa in opera.

Magnetic lock. The latch is independent from the magnet and always allows the closing of the door. Adjustable frame striker that aids the fitting stages.

Serratura libero/occupato minimale della versione scorrevole Minimal lock of the sliding version

Cerniera di tipo Anuba registrabile su 3 assi 3 axle adjustable hinge



Sigillo di autenticità Authenticity seal



Particolare di anubatura tra anta e telaio Hinge details between leaf and frame

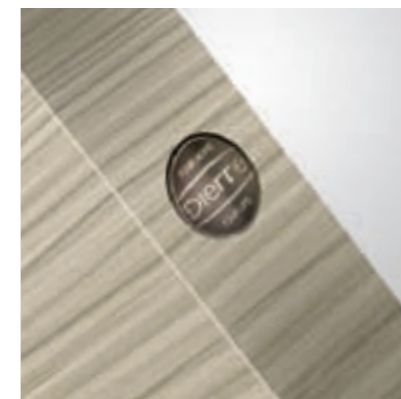

Versione Cieca con inserti
Colore Matrix bianco
Coprifilo M90/T90 taglio a 90°
Variant Blank with inserts
Colour White matrix
Cover mould M90/T90 with 90° cut



Versione Finestrata
Colore Matrix bianco
Coprifilo M90/T90 taglio a 90°
Variant Glazed
Colour White matrix
Cover mould M90/T90 with 90° cut



Versione Finestrata lato serratura
Colore Marmorizzato beton maloja
Coprifilo M90/T90 taglio a 90°
Variant Left hand glazing
Colour Marbled beton maloja
Cover mould M90/T90 with 90° cut



Versione Finestrata lato cerniera
Colore Alter noce tabacco
Coprifilo M90/T90 taglio a 90°
Variant Right hand glazing
Colour Alter tobacco walnut
Cover mould M90/T90 with 90° cut

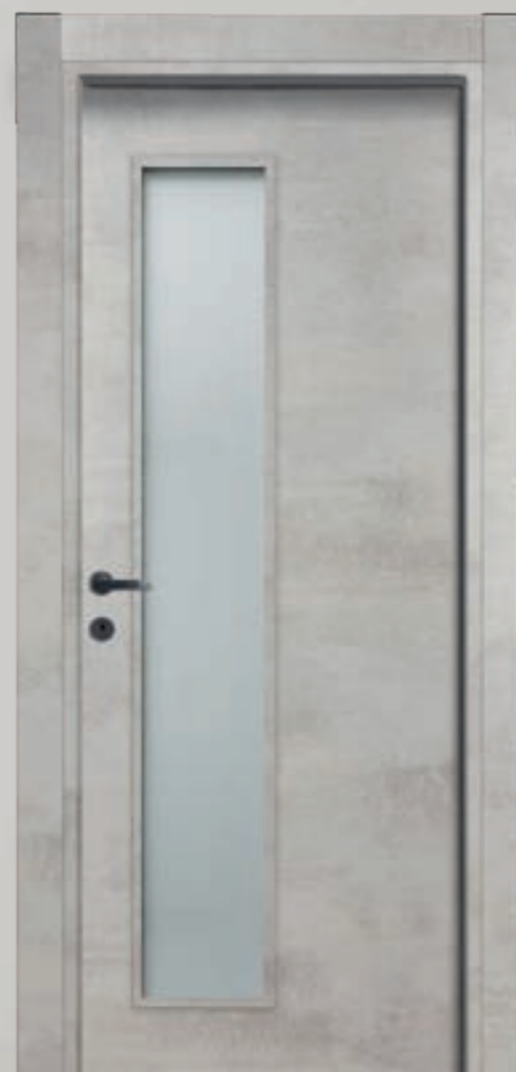

new

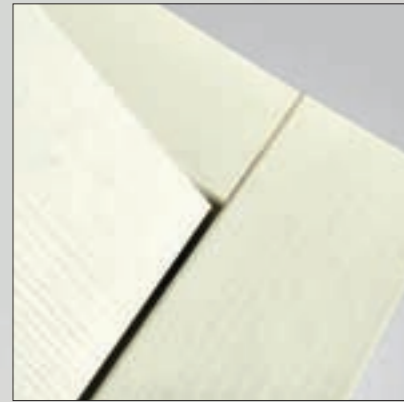

Versione a tirare
Pull version

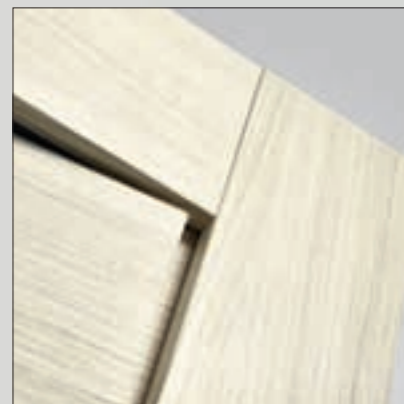

Versione a spingere
Push version

Versione	Rasé cieca
Colore	Matrix palissandro bianco
Coprifilo	M90/T90 taglio a 90°
Variant	Blank Rasé
Colour	White rosewood matrix
Cover mould	M90/T90 with 90° cut



new



















Versione	Filum cieca
Colore	Bianco B011
Variant	Blank Filum
Colour	B011 white

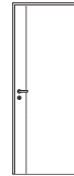



NOTA Nella versione Rasé tutta altezza il senso della vena è invertito
NOTE: in the full height Rasé version the grain direction is reversed

allestimenti *lines*













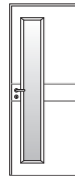



ISY 1 cieca -finitura inox/ottone *blank - steel/brass inserts*

																
cieca <i>blank</i>	cieca a 2 riquadri <i>blank with 2 sections</i>	cieca con riquadro centrale <i>blank with central panel</i>	cieca a 3 riquadri <i>blank with 3 sections</i>	cieca a 4 riquadri <i>blank with 4 sections</i>	cieca a 5 riquadri <i>blank with 5 sections</i>	2 coppie inserti orizzontali <i>2 pairs of horizontal inserts</i>	1 coppia inserti centrale <i>1 pair of central inserts</i>	1 coppia inserti sup. e inf <i>1 pair of upper and lower inserts</i>	1 inserto vert. sinistro <i>1 left vertical insert</i>	1 inserto vert. destro <i>1 right vertical insert</i>	1 coppia inserti vert. sinistra <i>1 pair of left vertical inserts</i>	1 coppia inserti vert. destra <i>1 pair of right vertical inserts</i>	2 inserti verticali <i>2 vertical inserts</i>	inserti diagonali <i>diagonal inserts</i>	inserti diagonali <i>diagonal inserts</i>	inserti diagonali <i>diagonal inserts</i>















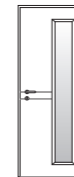

ISY 2 finestrata centrale - finitura inox/ottone *glazed - steel/brass inserts*

																
finestrata <i>glazed</i>	finestrata a 2 riquadri <i>glazed with 2 panes</i>	finestrata con riquadro centrale <i>glazed with central pane</i>	finestrata a 3 riquadri <i>glazed with 3 panes</i>	finestrata a 4 riquadri <i>glazed with 4 panes</i>	finestrata a 5 riquadri <i>glazed with 5 panes</i>	2 coppie inserti orizzontali <i>2 pairs of horizontal inserts</i>	1 coppia inserti centrale <i>1 pair of central inserts</i>	1 coppia inserti sup. e inf <i>1 pair of upper and lower inserts</i>	1 inserto vert. sinistro <i>1 left vertical insert</i>	1 inserto vert. destro <i>1 right vertical insert</i>	1 coppia inserti vert. sinistra <i>1 pair of left vertical inserts</i>	1 coppia inserti vert. destra <i>1 pair of right vertical inserts</i>	2 inserti verticali <i>2 vertical inserts</i>	inserti diagonali <i>diagonal inserts</i>	inserti diagonali <i>diagonal inserts</i>	inserti diagonali <i>diagonal inserts</i>

ISY 3 finestrata sinistra - finitura inox/ottone *glazed - steel/brass inserts*

																
finestrata <i>glazed</i>	finestrata a 2 riquadri <i>glazed with 2 panes</i>	finestrata con riquadro centrale <i>glazed with central pane</i>	finestrata a 3 riquadri <i>glazed with 3 panes</i>	finestrata a 4 riquadri <i>glazed with 4 panes</i>	finestrata a 5 riquadri <i>glazed with 5 panes</i>	2 coppie inserti orizzontali <i>2 pairs of horizontal inserts</i>	1 coppia inserti centrale <i>1 pair of central inserts</i>	1 coppia inserti sup. e inf <i>1 pair of upper and lower inserts</i>	1 inserto vert. sinistro <i>1 left vertical insert</i>	1 inserto vert. destro <i>1 right vertical insert</i>	1 coppia inserti vert. sinistra <i>1 pair of left vertical inserts</i>	1 coppia inserti vert. destra <i>1 pair of right vertical inserts</i>	2 inserti verticali <i>2 vertical inserts</i>	inserti diagonali <i>diagonal inserts</i>	inserti diagonali <i>diagonal inserts</i>	inserti diagonali <i>diagonal inserts</i>

ISY 4 finestrata destra - finitura inox/ottone *glazed - steel/brass inserts*

																
finestrata <i>glazed</i>	finestrata a 2 riquadri <i>glazed with 2 panes</i>	finestrata con riquadro centrale <i>glazed with central pane</i>	finestrata a 3 riquadri <i>glazed with 3 panes</i>	finestrata a 4 riquadri <i>glazed with 4 panes</i>	finestrata a 5 riquadri <i>glazed with 5 panes</i>	2 coppie inserti orizzontali <i>2 pairs of horizontal inserts</i>	1 coppia inserti centrale <i>1 pair of central inserts</i>	1 coppia inserti sup. e inf <i>1 pair of upper and lower inserts</i>	1 inserto vert. sinistro <i>1 left vertical insert</i>	1 inserto vert. destro <i>1 right vertical insert</i>	1 coppia inserti vert. sinistra <i>1 pair of left vertical inserts</i>	1 coppia inserti vert. destra <i>1 pair of right vertical inserts</i>	2 inserti verticali <i>2 vertical inserts</i>	inserti diagonali <i>diagonal inserts</i>	inserti diagonali <i>diagonal inserts</i>	inserti diagonali <i>diagonal inserts</i>



Isy Rasé matrix palissandro bianco
Isy Rasé white rosewood matrix

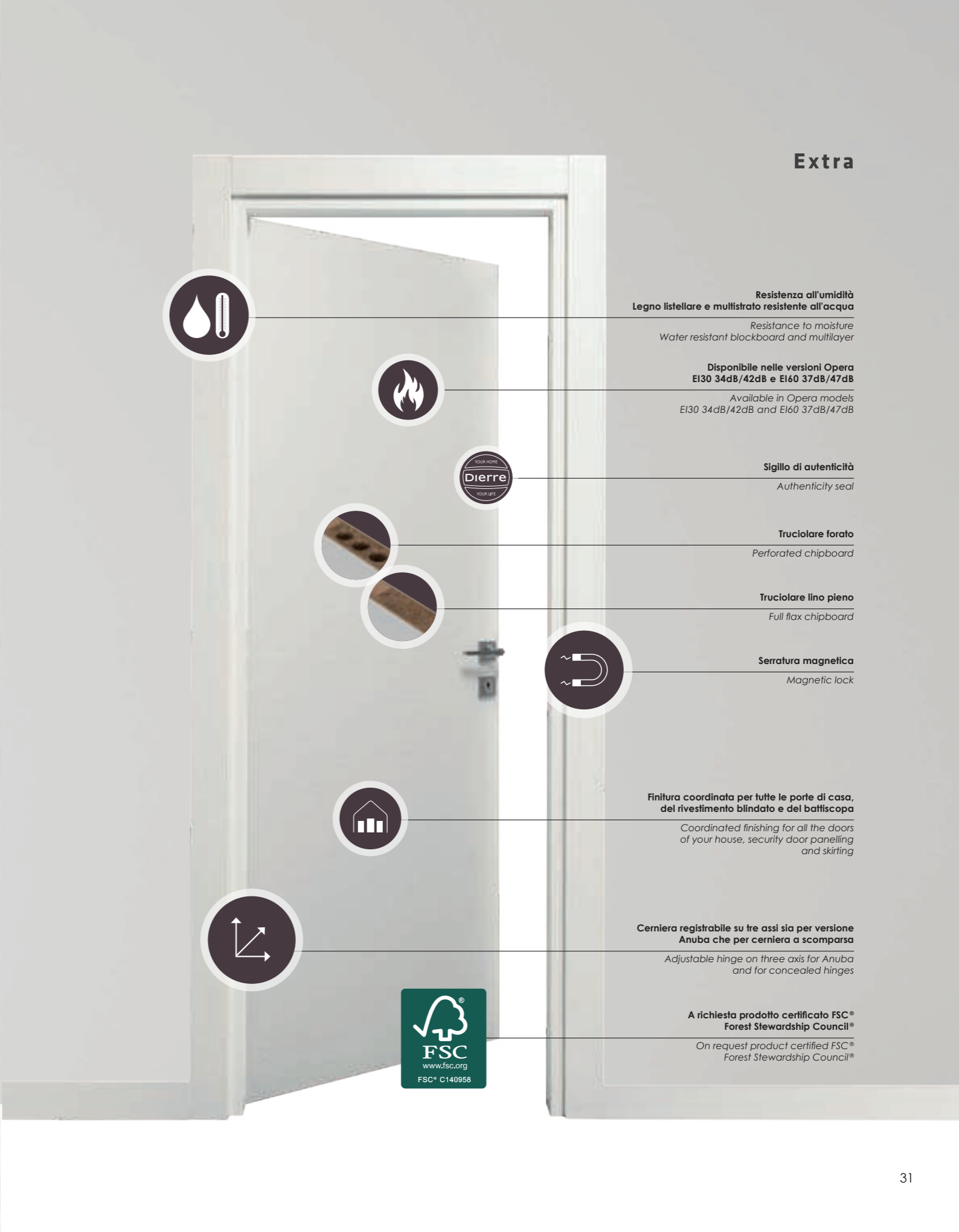

Extra



Resistenza all'umidità
Legno listellare e multistrato resistente all'acqua
Resistance to moisture
Water resistant blockboard and multilayer



Disponibile nelle versioni Opera
EI30 34dB/42dB e EI60 37dB/47dB
Available in Opera models
EI30 34dB/42dB and EI60 37dB/47dB



Sigillo di autenticità
Authenticity seal

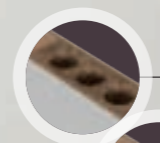

Truciolare forato
Perforated chipboard

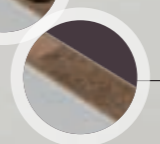

Truciolare lino pieno
Full flax chipboard



Serratura magnetica
Magnetic lock



Finitura coordinata per tutte le porte di casa,
del rivestimento blindato e del battiscopa
Coordinated finishing for all the doors
of your house, security door panelling
and skirting



Cerniera registrabile su tre assi sia per versione
Anuba che per cerniera a scomparsa
Adjustable hinge on three axis for Anuba
and for concealed hinges



A richiesta prodotto certificato FSC®
Forest Stewardship Council®
On request product certified FSC®
Forest Stewardship Council®

soluzioni di apertura *opening variant*

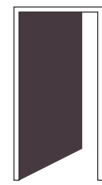

Battente singolo
Single leaf



Doppio battente
Double leaf

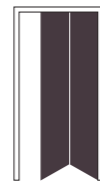

Porta pieghevole a libro singola
Single folding door



Anta pieghevole 1/3 - 2/3
Folding door 1/3 - 2/3



Anta rototraslante
Rototranslating door



Scorrevole interno muro singolo
Single leaf sliding inside the wall



Scorrevole interno muro 2 ante
Two opposing leaves sliding inside the wall



Scorrevole esterno muro
One leaf sliding outside the wall



Scorrevole esterno muro Magic
Magic one leaf sliding outside the wall



Porta ad un'anta con cerniere Bommer
Bommer



Porta a due ante con cerniere Bommer
Double Bommer



Rasé
Rasé



Filum
Filum



Trapezoidale
Slanted door

soluzioni telaio in legno *wooden frame options*



TELAIO STANDARD con cerniera Anuba
STANDARD FRAME with Anuba hinge

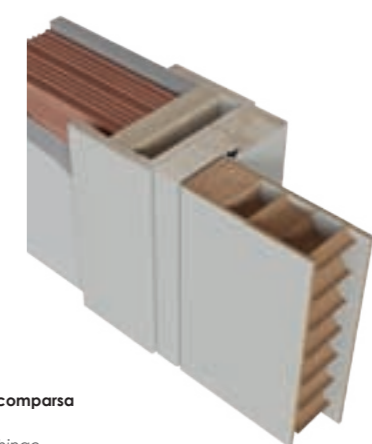

TELAIO SPECIALE con cerniera a scomparsa
Special frame with concealed hinge



new
TELAIO RASÉ SPINGERE con cerniera a scomparsa
PUSH RASÉ FRAME with concealed hinge



new
TELAIO RASÉ TIRARE con cerniera a scomparsa
PULL RASÉ FRAME with concealed hinge

soluzioni telaio in alluminio *aluminium frame solutions*



TELAIO ALUTEC/FUSION con cerniera a scomparsa e/o a bandella
ALUTEC/FUSION FRAME with flap concealed hinge



new
TELAIO FILUM con cerniera a scomparsa
FILUM FRAME with concealed hinge

soluzioni telaio per porte tagliafuoco
frame solutions for fire doors

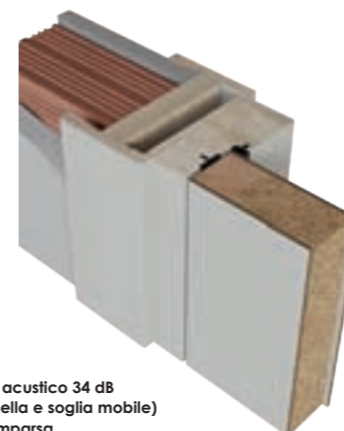

TELAIO EI30
 con allestimento acustico 34 dB
 (cerniere a bandella e soglia mobile)
 e cerniere a scomparsa
EI30 FRAME
 With sound-proofing fitting 34 dB
 (flap concealed hinge and mobile threshold)
 and with concealed hinge

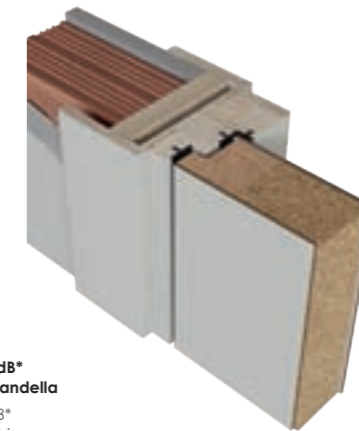

TELAIO EI60 - 37 dB*
 con cerniera a bandella
*EI60 FRAME 37 dB**
 with concealed hinge

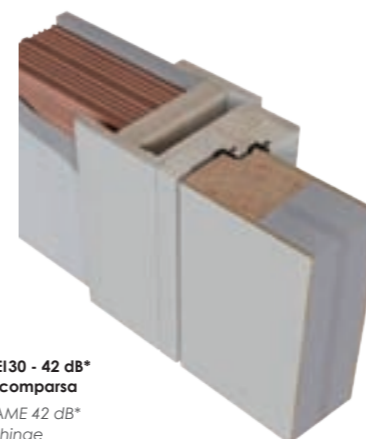

new
TELAIO D SUPER EI30 - 42 dB*
 con cerniera a scomparsa
*EI30 D SUPER FRAME 42 dB**
 with concealed hinge

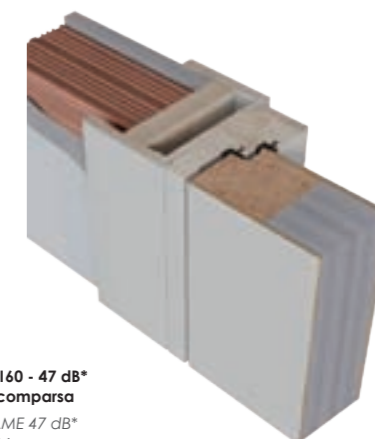

new
TELAIO D SUPER EI60 - 47 dB*
 con cerniera a scomparsa
*EI60 D SUPER FRAME 47 dB**
 with concealed hinge

* Con allestimento acustico / With sound-proofing fitting



Maniglia Blade in cromo satinato
Satin chrome Blade handle

essenze e colorazioni *wood types and colors*

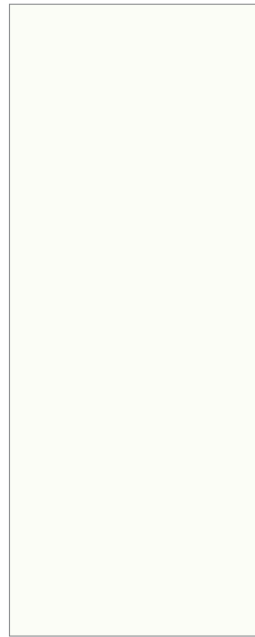

Bianco B011
B011 White

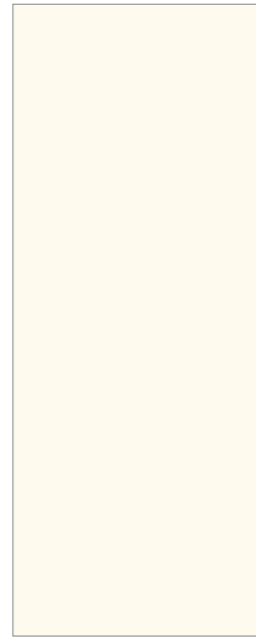

Avorio B003
B003 Ivory



Matrix bianco
White matrix

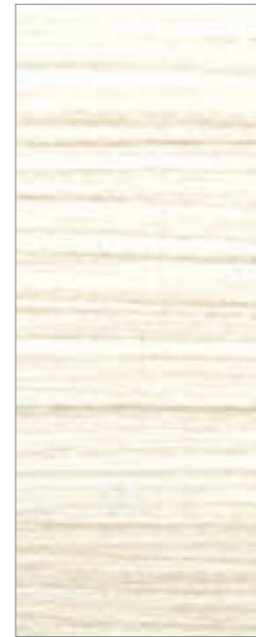

Matrix palissandro bianco
White rosewood matrix

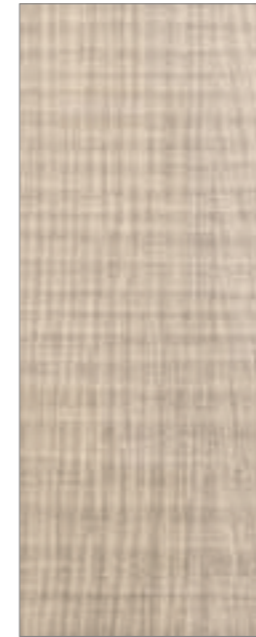

Rovere sbiancato tranché
Bleached tranché oak

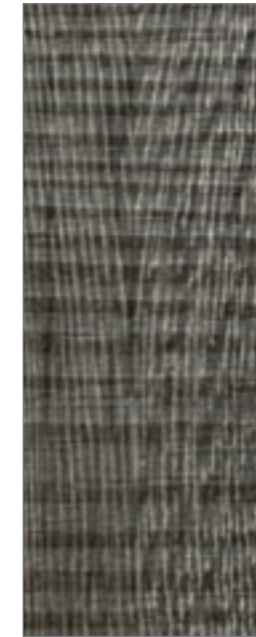

Rovere grigio tranché
Gray tranché oak

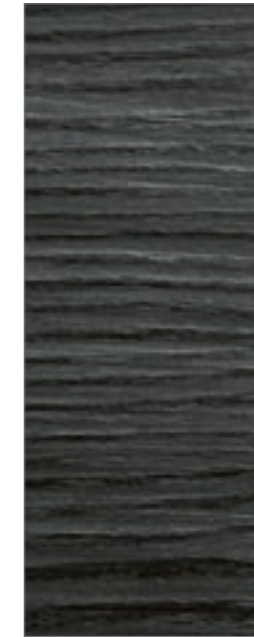

Matrix palissandro blu
Blue rosewood matrix



Marmorizzato beton maloja
Marbled beton maloja

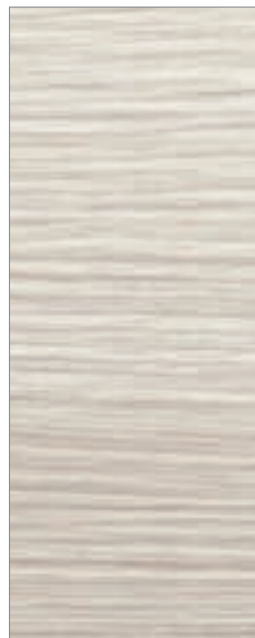

Oregon pine
Oregon pine

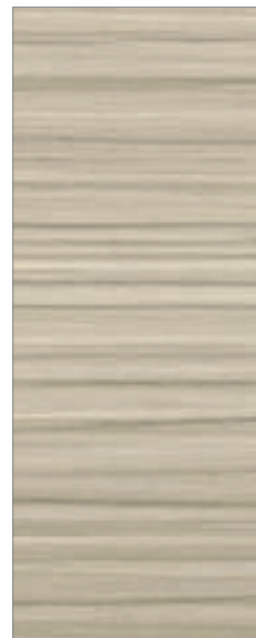

Matrix larice sabbia
Sand larch matrix

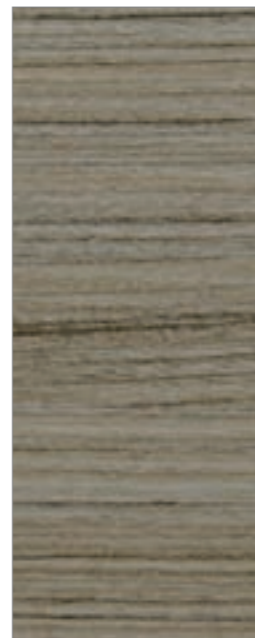

Matrix Palissandro grigio
Gray rosewood matrix



Alter noce tabacco
Alter tobacco walnut

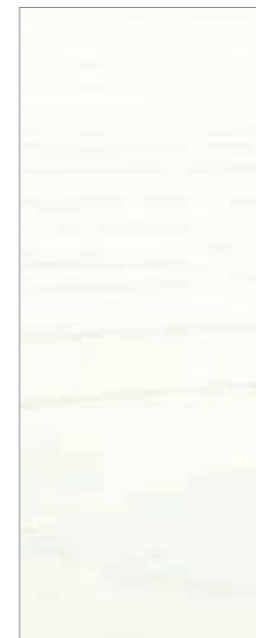

Bianco azimut
Azimut white



RAL Laccato RAL liscio millecolori
One thousand colors
RAL lacquered

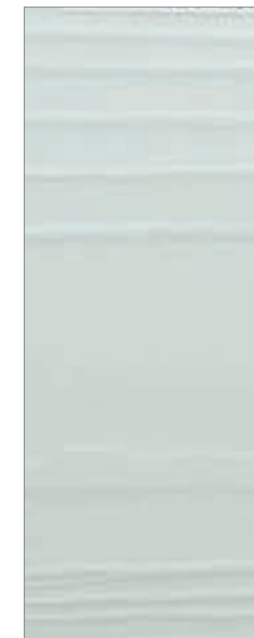

RAL Laccato RAL spazzolato millecolori
One thousand colors
RAL brushed lacquered

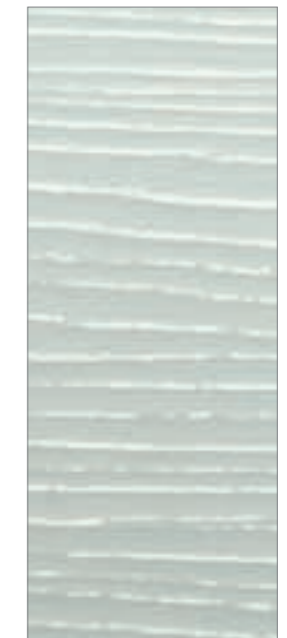

RAL Laccato RAL spazzolato sfumatura millecolori
One thousand colors shades
RAL brushed lacquered



Light Plus palissandro grigio matrix
Light Plus matrix gray rosewood

EXPRESS COLLECTION



Le linee Vintage e Light Plus costituiscono una collezione snella e meno articolata ma con in più il servizio di pronta consegna Dierre express che garantisce l'abbattimento drastico dei tempi: solo 4-7 giorni lavorativi, dall'ordine alla consegna.*

The Vintage and Light Plus lines make up a lean and less articulated collection having though the Dierre express delivery service that guarantees the drastic reduction of production time: only 4-7 working days, from order to delivery.*



- consegna 4 giorni
delivery 4 days
- consegna 6 giorni
delivery 6 days
- consegna 7 giorni
delivery 7 days

* Maggiorazione del 10% sul costo di trasporto; ordine minimo: 3 porte.
10% increase on transport cost; minimum order: 3 doors.



VINTAGE



LIGHT PLUS

VINTAGE & LIGHT PLUS COLLECTION



Due linee in laminatino, Vintage e Light plus, esprimono l'evoluzione dei materiali utilizzati per l'arredamento e i rivestimenti della casa.

Tra i molteplici pregi del laminatino ci sono la versatilità e la capacità di imitare bene le caratteristiche del legno e di altre texture.

Two lines in laminated material, Vintage and Light plus, express the evolution of materials used house furnishing and panelling. Laminated materials offer the utmost versatility and the ability to well imitate the features of both wood and other textures.



Telaio realizzato in listellare e rivestito in laminatino, completo di guarnizione di battuta, contropiastra nichelata, ferrato con 3 cerniere tipo Anuba. I coprifili in multistrato da 7 cm con alette da 2,5 cm compensano le variabili di spessore del muro.

Frame made of plywood and coated in laminated material, complete with stop seal, nickel-plated counterplate and equipped with 3 Anuba type hinges. The 7 cm plywood casing with 2.5 cm flaps balance any variables in the thickness of the wall.



Serratura meccanica centromediana con scrocco in teflon antirumore.

Mechanical lock with noise-proof teflon latch.



Cerniera e incontro cromo con vaschetta

Hinge and chrome striker with tray.

Serratura libero/occupato minimale della versione scorrevole (a richiesta)
Minimal lock of the sliding version (on request)



Anubatura tra anta e telaio
Hinge details between leaf and frame



VINTAGE



Versione Vintage 1
cieca a 5 riquadri inserti inox

Colore Olmo perla

Coprifilo Modello Style
dimensione mm 70x10

Telaio Listellare

Variant Vintage 1
blank with 5 sections

Colour Pearl elm

Cover mould Style model dimension mm 70x10

Frame Plywood



Versione Vintage 1
coppia di inserti inox

Colore Olmo bianco

Coprifilo Modello Style
dimensione mm 70x10

Telaio Listellare

Variant Vintage 1
1 pair of inox inserts

Colour White elm

Cover mould Style model dimension mm 70x10

Frame Plywood



Versione Vintage 1

Colore Noce nazionale

Coprifilo Modello Style
dimensione mm 70x10

Telaio Listellare

Variant Vintage

Colour Italian walnut

Cover mould Style model dimension
mm 70x10

Frame Plywood



Versione Vintage 1
con 4 inserti orizzontali inox

Colore Ciliegio

Coprifilo Modello Style
dimensione mm 70x10

Telaio Listellare

Variant Vintage
4 horizontal inox inserts

Colour Cherry wood

Cover mould Style model dimension mm 70x10

Frame Plywood

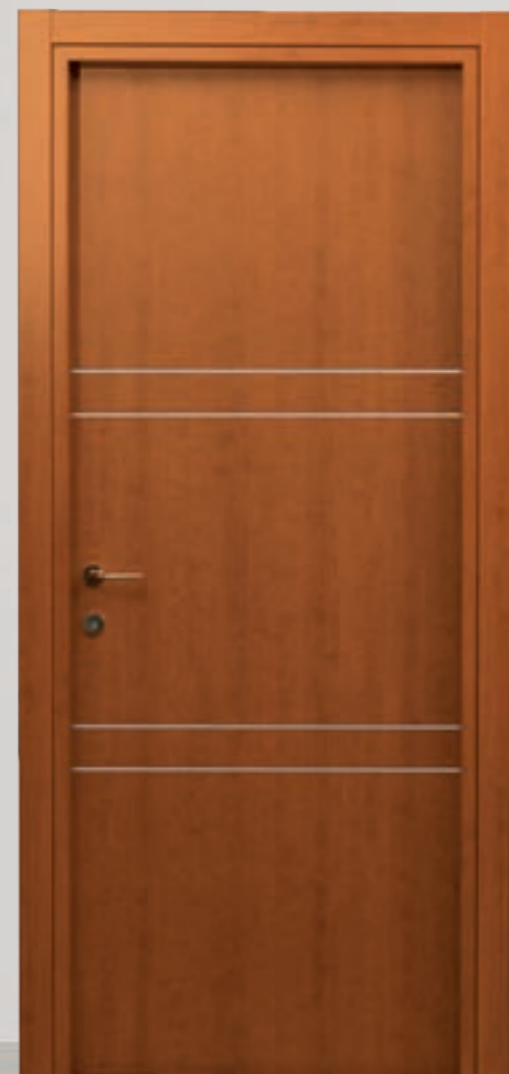
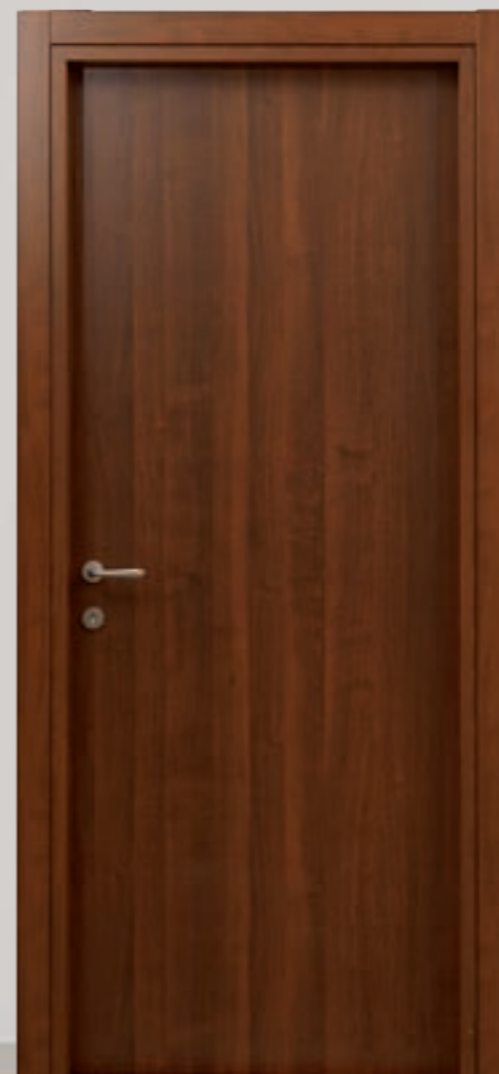



Versione Vintage 1
Color Bianco
Coprifilo Modello Style
 dimensione mm 70x10
Telaio Listellare
Variant *Vintage diagonal inserts*
Colour *White*
Cover mould *Style model dimension*
 mm 70x10
Frame *Plywood*





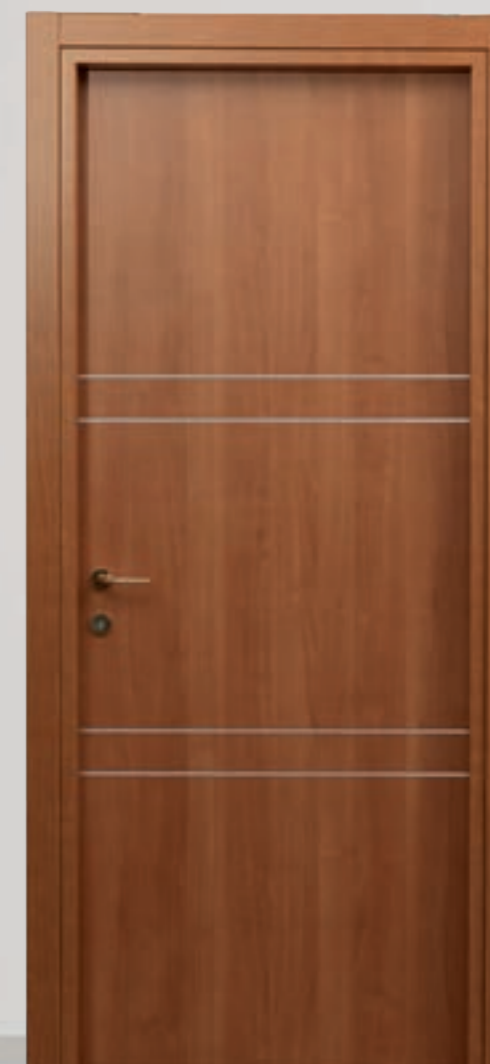







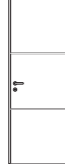























Versione Vintage 1 con 4 inserti orizzontali
 in cromo satinato
Color Tanganica
Coprifilo Modello Style
 dimensione mm 70x10
Telaio Listellare
Variant *Vintage*
4 horizontal inserts satin chrome
Colour *Light tanganika*
Cover mould *Style model dimension mm 70x10*
Frame *Plywood*





















allestimenti *lines*



VINTAGE 1

						
cieca blank	cieca a 2 riquadri blank with 2 sections	cieca a 3 riquadri blank with 3 sections	cieca a 4 riquadri blank with 4 sections	cieca a 5 riquadri blank with 5 sections	coppia inserti 1 pair of inserts	cieca con riquadro centrale blank with central panel
						
inserti verticali vertical inserts	inserti diagonali diagonal inserts	2 inserti verticali dx 2 right vertical inserts	2 inserti verticali sx 2 left vertical inserts	4 inserti orizzontali 4 horizontal inserts	inserti diagonali diagonal inserts	inserti diagonali diagonal inserts
						
finestrata glazed	finestrata a 2 riquadri glazed with 2 panes	finestrata a 3 riquadri glazed with 3 panes	finestrata a 4 riquadri glazed with 4 panes	finestrata a 5 riquadri glazed with 5 panes	finestrata coppia inserti glazed 1 pair of inserts	finestrata con riquadro centrale glazed with central panel
						
finestrata con riquadro centrale glazed with central panel	finestrata con inserti verticali glazed with vertical inserts	finestrata con inserti diagonali glazed with diagonal inserts	finestrata con 2 inserti dx glazed with 2 right inserts	finestrata con 2 inserti sx glazed with 2 left inserts	finestrata con 4 inserti orizzontali glazed with 4 horizontal inserts	finestrata con 4 inserti orizzontali glazed with 4 horizontal inserts
						
finestrata glazed	finestrata a 2 riquadri glazed with 2 panes	finestrata a 3 riquadri glazed with 3 panes	finestrata a 4 riquadri glazed with 4 panes	finestrata a 5 riquadri glazed with 5 panes	finestrata coppia inserti glazed with central pane	finestrata coppia inserti glazed with central pane

VINTAGE 1

					
finestrata con riquadro centrale glazed with central pane	finestrata con inserti verticali glazed with vertical inserts	finestrata con inserti diagonali glazed with diagonal inserts	finestrata con 2 inserti dx glazed with 2 right inserts	finestrata con 2 inserti sx glazed with 2 left inserts	finestrata con 4 inserti orizzontali glazed with 4 horizontal inserts
					
finestrata glazed	finestrata a 2 riquadri glazed with 2 panes	finestrata a 3 riquadri glazed with 3 panes	finestrata a 4 riquadri glazed with 4 panes	finestrata a 5 riquadri glazed with 5 panes	finestrata coppia inserti glazed 1 pair of inserts
					
finestrata con riquadro centrale glazed with central panel	finestrata con inserti verticali glazed with vertical inserts	finestrata con inserti diagonali glazed with diagonal inserts	finestrata con 2 inserti dx glazed with 2 right inserts	finestrata con 4 inserti orizzontali glazed with 4 horizontal inserts	finestrata con 4 inserti orizzontali glazed with 4 horizontal inserts

VINTAGE 2

		
cieca con 2 bugne blank with 2 raised panels	finestrata con bugna glazed with raised panel	cieca con 1 bugna blank with 1 raised panel

VINTAGE

soluzioni di apertura *opening variant*

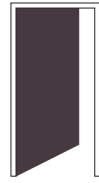

Battente singolo
Single leaf



Doppio battente
Double leaf



Porta pieghevole a libro singola
Single folding door



Anta pieghevole 1/3 - 2/3
Folding door 1/3 - 2/3



Anta rototraslante
Rototranslating door

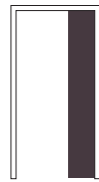

Scorrevole interno muro singolo
Single leaf sliding inside the wall



Scorrevole interno muro 2 ante
Two opposing leaves sliding inside the wall



Scorrevole esterno muro
One leaf sliding outside the wall



Scorrevole esterno muro senza telaio
Sliding externally to the wall without frame



Trapezoidale
Slanted door

soluzioni telaio in legno *wooden frame options*

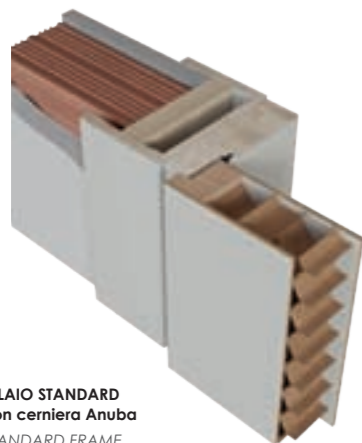

TELAIO STANDARD con cerniera Anuba
STANDARD FRAME with Anuba hinge



essenze e colorazioni *wood types and colors*

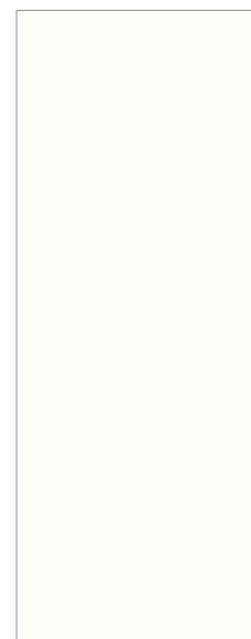

Bianco
White

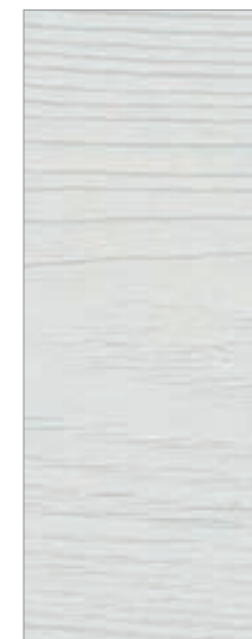

Olmo bianco
White elm



Olmo perla
Pearl elm



Tanganica biondo
Light tanganka



Ciliegio
Cherry wood



Noce nazionale
Italian walnut

LIGHT PLUS



Versione Light plus
Colore Larice sabbia matrix
Coprifilo Modello Style
 dimensione mm 70x10
Telaio Listellare
Variant Light plus
Colour Matrix sand larch
Cover mould Style model dimension mm 70x10
Frame Plywood



Versione Light plus
Colore Palissandro grigio matrix
Coprifilo Modello Style
 dimensione mm 70x10
Telaio Listellare
Variant Light plus
Colour Matrix gray rosewood
Cover mould Style model dimension mm 70x10
Frame Plywood



Versione Light plus
Colore Bianco matrix
Coprifilo Modello Style
 dimensione mm 70x10
Telaio Listellare
Variant Light plus
Colour Matrix white
Cover mould Style model dimension mm 70x10
Frame Plywood



Versione Light plus
Colore Bianco azimuth
Coprifilo Modello Style
 dimensione mm 70x10
Telaio Listellare
Variant Light plus
Colour Azimut white
Cover mould Style model dimension mm 70x10
Frame Plywood





Versione	Light plus	
Colore	Palissandro bianco matrix	
Coprifilo	Modello Style dimensione mm 70x10	
Telaio	Listellare	
Variant	Light plus	
Colour	Matrix white rosewood	
Cover mould	Style model dimension mm 70x10	
Frame	Plywood	

Versione	Light plus	
Colore	Marmorizzato beton maloja	
Coprifilo	Modello Style dimensione mm 70x10	
Telaio	Listellare	
Variant	Light plus	
Colour	Marbled beton maloja	
Cover mould	Style model dimension mm 70x10	
Frame	Plywood	



allestimenti *lines*



cieca
blank

soluzioni di apertura *opening variant*



Battente singolo
Single leaf



**Scorrevole interno
muro singolo**
*Single leaf sliding
inside the wall*

soluzioni telaio in legno *wooden frame options*



**TELAIO STANDARD
con cerniera Anuba**
*STANDARD FRAME
with Anuba hinge*

essenze e colorazioni *wood types and colors*

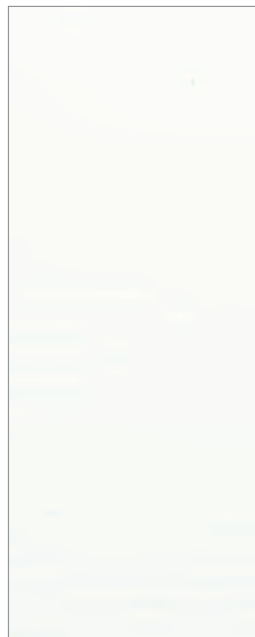

Bianco matrix
Matrix white



Bianco azimut
Azimut white

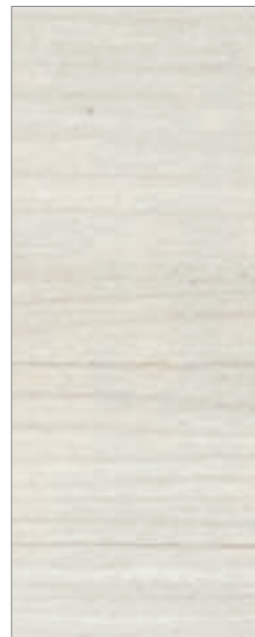

Palissandro bianco 2302 matrix
Matrix 2302 white rosewood

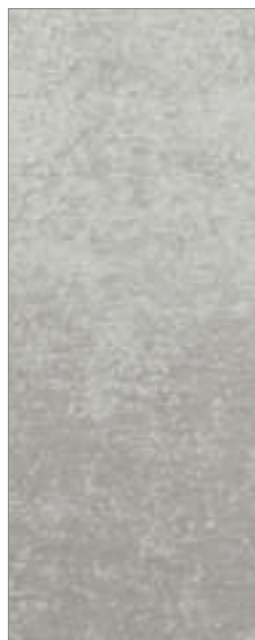

Marmorizzato beton maloja
Marbled beton maloja

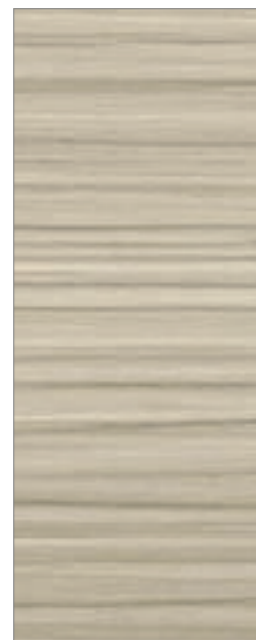

Larice sabbia matrix
Matrix sand larch

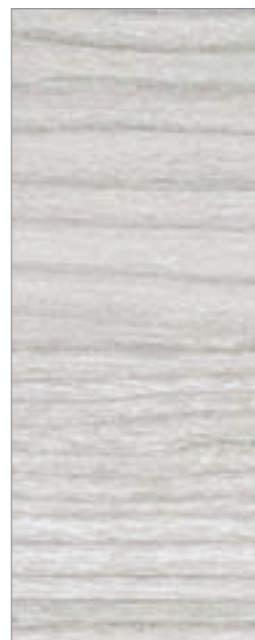

Palissandro grigio matrix
Matrix gray rosewood





New Twin Set 1 acero bianco
New Twin Set 1 white maple

NEW TWIN SET

Porta nobilitata in laminatino liscia, dal design lineare, moderno ed essenziale per ogni ambiente della casa, disponibile in sette diverse finiture.

Flush laminate door, with a linear, modern and essential design for every room of the house, available in seven different finishes.



NEW TWIN SET

NEW TWIN SET

La struttura del telaio e dei coprifili in MDF, la presenza della guarnizione di battuta e lo scrocco in teflon contribuiscono al comfort acustico di una porta che è tutta sostanza.

The full essence of the door is in the frame structure and the MDF casing, the presence of the stop seal and the teflon latch that enhance the acoustic comfort.



Telaio realizzato in MDF e rivestito in laminatino, completo di guarnizione di battuta, contropiastra nichelata e ferrato con 3 cerniere tipo Anuba. I coprifili da 7 cm con alette da 2,8 cm compensano le variabili di spessore del muro.

Frame made of MDF and laminate panelled, complete with stop frame seal, nickel-treated counter plate and equipped with 3 Anuba hinges. The 7 cm casing with 2,8 cm flaps balance the thickness unevenness of the wall.



Serratura meccanica centromediana con scrocco in teflon antirumore

Mechanical lock with noise-proof teflon latch



Serratura libero/occupato minimale della versione scorrevole (a richiesta)

Minimal lock of the sliding version (on request)



Sigillo di autenticità

Authenticity seal

NEW TWIN SET

NEW TWIN SET

Versione New Twin Set 1
Colore Acero bianco
Coprifilo Modello Essenziale
 dimensione mm 70x10

Variant New Twin Set 1
Colour White maple
Cover mould Essenziale model
 dimension mm 70x10



Versione New Twins Set 1 con inserti
Colore Olmo corda
Coprifilo Modello Essenziale
 dimensione mm 70x10

Variant New Twin Set 1 with inserts
Colour Rope elm
Cover mould Essenziale model
 dimension mm 70x10



Versione New Twin Set 1 con inserti
Colore Bianco
Coprifilo Modello Essenziale
 dimensione mm 70x10

Variant New Twin Set 1 with inserts
Colour White
Cover mould Essenziale model
 dimension mm 70x10















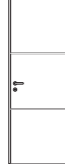



















Versione New Twin Set 2
 cieca con bugna
Colore Grigio perla
Coprifilo Modello Essenziale
 dimensione mm 70x10

Variant New Twin Set 2
 blank with raised panel
Colour Pearl grey
Cover mould Essenziale model
 dimension mm 70x10





















allestimenti *lines*



NEW TWIN SET 1

						
cieca blank	cieca a 2 riquadri blank with 2 sections	cieca a 3 riquadri blank with 3 sections	cieca a 4 riquadri blank with 4 sections	cieca a 5 riquadri blank with 5 sections	coppia inserti 1 pair of inserts	cieca con riquadro centrale blank with central panel
						
inserti verticali vertical inserts	inserti diagonali diagonal inserts	2 inserti verticali dx 2 right vertical inserts	2 inserti verticali sx 2 left vertical inserts	4 inserti orizzontali 4 horizontal inserts	inserti diagonali diagonal inserts	inserti diagonali diagonal inserts
						
finestrata glazed	finestrata a 2 riquadri glazed with 2 panes	finestrata a 3 riquadri glazed with 3 panes	finestrata a 4 riquadri glazed with 4 panes	finestrata a 5 riquadri glazed with 5 panes	finestrata coppia inserti glazed 1 pair of inserts	
						
finestrata con riquadro centrale glazed with central panel	finestrata con inserti verticali glazed with vertical inserts	finestrata con inserti diagonali glazed with diagonal inserts	finestrata con 2 inserti dx glazed with 2 right inserts	finestrata con 2 inserti sx glazed with 2 left inserts	finestrata con 4 inserti orizzontali glazed with 4 horizontal inserts	
						
finestrata glazed	finestrata a 2 riquadri glazed with 2 panes	finestrata a 3 riquadri glazed with 3 panes	finestrata a 4 riquadri glazed with 4 panes	finestrata a 5 riquadri glazed with 5 panes	finestrata coppia inserti glazed with central panel	

NEW TWIN SET 1

					
finestrata con riquadro centrale glazed with central pane	finestrata con inserti verticali glazed with vertical inserts	finestrata con inserti diagonali glazed with diagonal inserts	finestrata con 2 inserti dx glazed with 2 right inserts	finestrata con 2 inserti sx glazed with 2 left inserts	finestrata con 4 inserti orizzontali glazed with 4 horizontal inserts
					
finestrata glazed	finestrata a 2 riquadri glazed with 2 panes	finestrata a 3 riquadri glazed with 3 panes	finestrata a 4 riquadri glazed with 4 panes	finestrata a 5 riquadri glazed with 5 panes	finestrata coppia inserti glazed 1 pair of inserts
					
finestrata con riquadro centrale glazed with central panel	finestrata con inserti verticali glazed with vertical inserts	finestrata con inserti diagonali glazed with diagonal inserts	finestrata con 2 inserti dx glazed with 2 right inserts	finestrata con 4 inserti orizzontali glazed with 4 horizontal inserts	finestrata con 4 inserti orizzontali glazed with 4 horizontal inserts

NEW TWIN SET 2

		
cieca con 2 bugne blank with 2 raised panels	finestrata con bugna glazed with raised panel	cieca con 1 bugna blank with 1 raised panel

NEW TWIN SET

Extra



Sigillo di autenticità
Authenticity seal

**Finitura coordinata per tutte le porte di casa,
del rivestimento blindato e del battiscopa**
*Coordinated finishing for all the doors
of your house, security door panelling
and skirting*

soluzioni di apertura *opening variant*

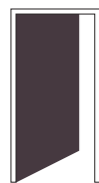

Battente singolo
Single leaf



Doppio battente
Double leaf

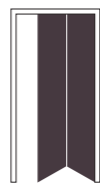

Porta pieghevole a libro singola *
*Single folding door **



Anta pieghevole 1/3 - 2/3 *
*Folding door 1/3 - 2/3 **



Anta rototraslante **
*Rototranslating door ***



Scorrevole interno muro singolo
Single leaf sliding inside the wall



Scorrevole interno muro 2 ante
Two opposing leaves sliding inside the wall



Scorrevole esterno muro senza telaio
One leaf sliding outside the wall without frame



Scorrevole esterno muro
One leaf sliding outside the wall



Trapezoidale
Slanted door



Battente singolo reversibile ***
*Single reversible wing ****

* Escluso modelli / *Excluding models:*
New Twin Set 1 FIN1
New Twin Set 1 FIN2
New Twin Set 1 FIN3
New Twin Set 2

** Escluso modelli / *Excluding models:*
New Twin Set 1 FIN2
New Twin Set 1 FIN3
New Twin Set 2

*** Escluso modelli / *Excluding models:*
New Twin Set 1 Lwa (FILA01, FILA14, FILA15, FILA16)
New Twin Set 1 Lwa (FILB01, FILB14, FILB15, FILB16)
New Twin Set 1 Lwa FIN1 (FILA01, FILA14)
New Twin Set 1 Lwa FIN1 (FILB01, FILB14)
New Twin Set 1 Lwa FIN2 (FILA01, FILA14)
New Twin Set 1 Lwa FIN2 (FILB01, FILB14)
New Twin Set 1 Lwa FIN3 (FILA01, FILA14)
New Twin Set 2 Lwb, Lwc

soluzioni telaio in legno *wooden frame options*



TELAIO STANDARD con cerniera Anuba
STANDARD FRAME with Anuba hinge

essenze e colorazioni *wood types and colors*

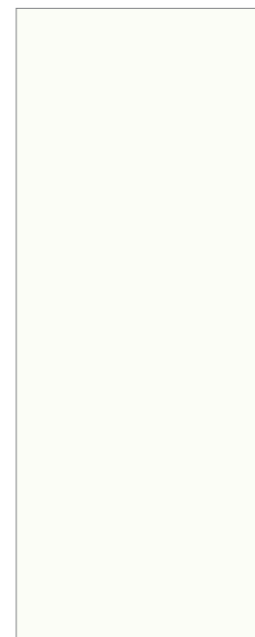

Bianco
White



Acero bianco
White maple

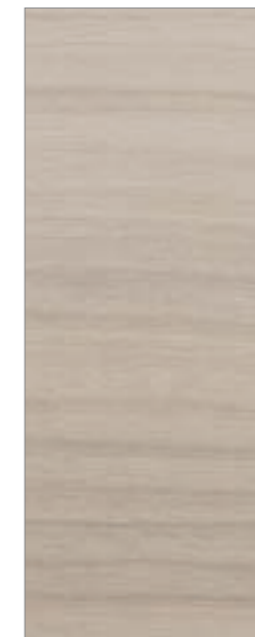

Olmo corda
Rope elm



Grigio perla
Pearl grey



Tanganica biondo
Light tanganika



Ciliegio
Cherry wood

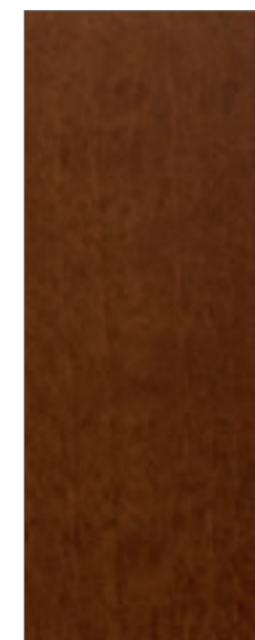

Noce nazionale
Italian walnut



tavola sinottica dei modelli *synoptic table of models*

	ISY COLLECTION		EXPRESS COLLECTION		NEW TWIN SET
	ISY PLUS	ISY	VINTAGE	LIGHT PLUS	
battente <i>leaf</i>					
laminatino tattile <i>tactile laminate</i>	•	•	-	-	-
laminatino liscio <i>flush laminate</i>			•	•	•
cieco <i>blank leaf</i>	•	•	•	•	•
vetrato <i>glazed leaf</i>	•	•	•	•	•
telaio <i>frame</i>					
listellare <i>blockboard</i>	•	•	•	•	-
MDF <i>MDF frame</i>	-	-	-	-	•
coprifilo multistrato rivestito laminatino <i>laminated multilayer casing</i>	•	•	•	•	-
coprifili in MDF rivestito in CPL <i>CPL-coated MDF casing</i>	-	-	-	-	•
disponibile in alluminio Alutec / Fusion <i>available in Alutec / Fusion aluminium</i>	-	•	-	-	-
anta e telaio assemblati <i>assembled leaf and frame</i>	-	•	-	-	-
tagliafuoco <i>firecut</i>					
disponibile versione Opera <i>Opera version available</i>	-	•	-	-	-
cerniere <i>hinges</i>					
Anuba <i>Anuba hinges</i>	•	•	•	•	•
a scomparsa <i>concealed hinges</i>	•	•			-
soluzioni di apertura <i>opening variant</i>					
battente singolo <i>single leaf</i>	•	•	•	•	•
doppio battente <i>double leaf</i>	•	•	•	-	•
scorrevole interno muro anta singola <i>single leaf sliding inside the wall</i>	•	•	•	•	•
scorrevole interno muro due ante <i>two opposing leaves sliding inside the wall</i>	•	•	•	-	•
scorrevole esterno muro anta singola <i>one leaf sliding outside the wall</i>	•	•	•	-	•
scorrevole esterno muro due ante <i>two leaf sliding outside the wall</i>	•	-	-	-	-
scorrevole esterno senza telaio <i>one leaf sliding outside the wall without frame</i>	-	•	•	-	•
porta ad un'anta con cerniere bommer <i>bommer</i>	-	•	-	-	-
porta a due ante con cerniere bommer <i>double bommer</i>	-	•	-	-	-
trapezoidale <i>slanted door</i>	-	•	•	-	•
pieghevole a libro <i>single folding door</i>	-	•	•	-	•
pieghevole 1/3 - 2/3 <i>folding door 1/3 - 2/3</i>	-	•	•	-	•
rotostraslante <i>rototranslating door</i>	-	•	•	-	•
Rasè <i>Rasè</i>	-	•	-	-	-
Filum <i>Filum</i>	-	•	-	-	-
reversibile <i>single reversible wing</i>	-	•	-	-	•
battente singolo con cerniere invisibili <i>single leaf with invisible hinges</i>	•	-	-	-	-

tavola sinottica dei modelli *synoptic table of models*

	ISY COLLECTION		V&L COLLECTION		
	ISY PLUS	ISY	VINTAGE	LIGHT PLUS	NEW TWIN SET
essenze e colorazioni <i>wood types and colors</i>					
acero bianco <i>white maple</i>	-	-	-	-	•
alter noce tabacco <i>alter tobacco walnut</i>	-	•	-	-	-
bianco <i>white</i>	-	-	•	-	•
bianco B011 <i>B011 white</i>	-	•	-	-	-
bianco azimut <i>azimut white</i>	-	•	-	•	-
avorio B003 <i>B003 ivory</i>	-	•	-	-	-
ciliegio <i>cherry wood</i>	-	-	•	-	•
grigio perla <i>pearl grey</i>	-	-	-	-	•
marmorizzato beton maloja <i>marbled beton maloja</i>	•	•	-	•	-
bianco matrix <i>matrix white</i>	•	•	-	•	-
larice sabbia matrix <i>matrix sand larch</i>	-	•	-	•	-
palissandro bianco matrix <i>matrix white rosewood</i>	•	•	-	•	-
palissandro blu matrix <i>matrix blue rosewood</i>	-	•	-	-	-
palissandro grigio matrix <i>matrix gray rosewood</i>	-	•	-	•	-
noce nazionale <i>italian walnut</i>	-	-	•	-	•
olmo bianco <i>white elm</i>	-	-	•	-	-
olmo corda <i>rope elm</i>	-	-	-	-	•
olmo perla <i>pearl elm</i>	-	-	•	-	-
oregon pine <i>oregon pine</i>	-	•	-	-	-
RAL millecolori <i>One thousand colors RAL lacquered</i>	-	•	-	-	-
RAL sfumature millecolori <i>One thousand colors shades RAL lacquered</i>	-	•	-	-	-
rovere grigio tranché <i>gray tranché oak</i>	-	•	-	-	-
rovere sbiancato tranché <i>bleached tranché oak</i>	-	•	-	-	-
tanganica biondo <i>light tanganika</i>	-	-	•	-	•
coordinato con porta blindata <i>coordinated finishing with security door</i>	-	•	•	•	•
misure standard <i>standard dimensions</i>					
larghezza cm <i>width in cm</i>	600 - 700 - 750 800 - 900	600 - 650 - 700 - 750 800 - 850 - 900	600 - 700 - 750 800 - 900	600 - 700 - 750 800 - 900	600 - 700 - 800
altezza cm <i>height in cm</i>	210	da 195 a 200	210	210	210
Dierre express					
pronta consegna in Italia (ordine minimo: 3 porte) <i>immediate delivery in Italy (minimum order: 3 doors)</i>	-	-	•	•	-
divisione Diere <i>Dierre division</i>					
stabilimento di produzione <i>production plant</i>	Wilab	Portedi	Wilab	Wilab	Wilab







Dierre Spa
Strada statale per Chieri 66/15
14019 Villanova D'Asti (At)
Tel 0141.949411
info@dierre.it

www.dierre.com